

Linear

LINI-S XL A040 (40W)

Fixture Guide

KKDÖ

Indoor | Surface | Output up to 3080lm/m (939lm/ft)

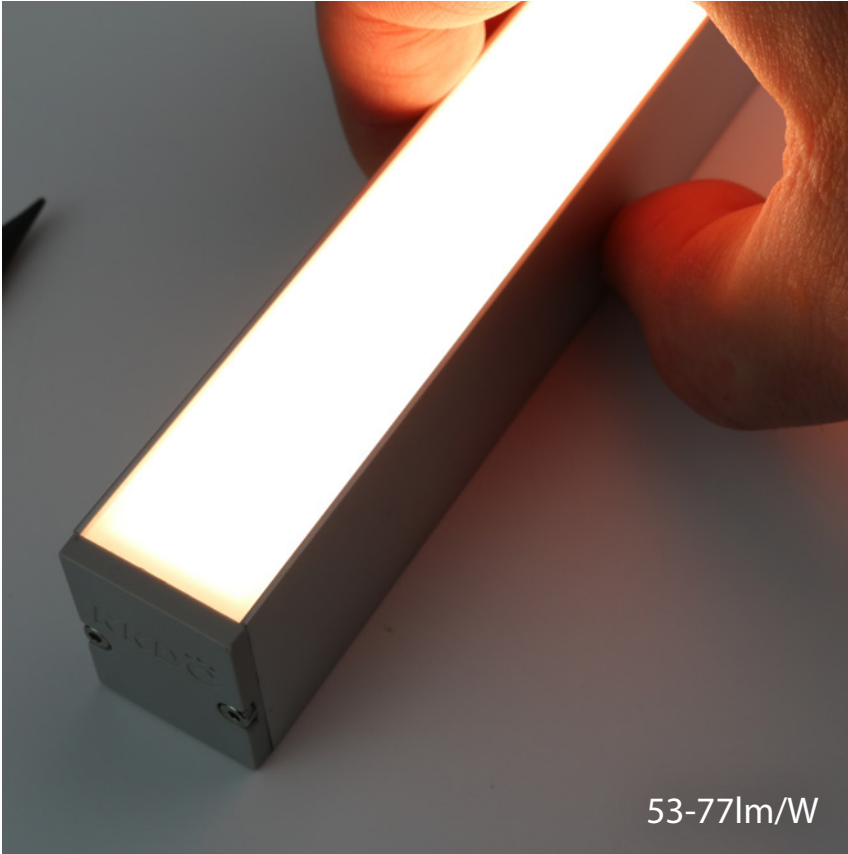

Key applications

- ✓ Architectural detail
- ✓ Mirror back lighting
- ✓ Cove lighting
- ✓ Retail display
- ✓ Direct lighting
- ✓ Shelving display
- ✓ Interior

Key features

- ✓ A-line (High Efficacy)
- ✓ Custom lengths
- ✓ Constant Voltage (CV)
- ✓ Diffusion: homogenous
- ✓ Direct view
- ✓ High lumen efficacy
- ✓ IP40 dry area

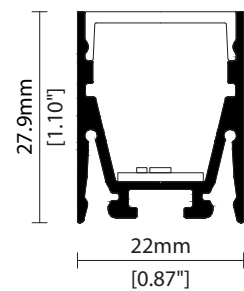

MOUNTING METHODS



KKCP-11 Concealed clip

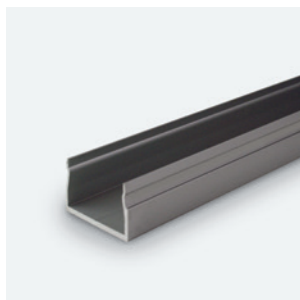

KKCR-01-1000 Cable raceway (1000mm)
KKCR-01-2000 Cable raceway (2000mm)
KKCR-01-3000 Cable raceway (3000mm)



KKJT-02 Joining bar

Linear

LINI-S XL A040 (40W)

Specification sheet



Dimensions	H28/W22/L88-1511mm (H1.1/W0.87/L3.46-59.49in)
PCB Cut-point	38.46mm increment/1500mm max (1.51in increment/59.06in max)
LED Pitch	4.8mm - 208LED/m (0.19in - 64LED/ft)
Chip	A-line
Cover/Optics	Clear (50°)/Diffused (120°)
CCT	A-line: 2700K/3000K/3500K/4000K
LED binning	A-line: 3-step MacAdam ellipse
CRI	≥94
Lifetime	50,000 hours @ 25°C (50,000 hours @ 77°F)
Operating temp	T _a = -25 to 50°C (T _c max = 86°C) T _a = -13 to 122°F (T _c max = 187°F)
IP Rating	IP40
Finish	Silver anodised
Mounting	Surface mounting via concealed clips
Power feed	Hardwire tails or male/female connectors
Control	0-10V/1-10V/DMX/DALI



LED Grading Key

Exclusive Grade *KKDC tuned CCT range
A-line* 3-step CCT range
 KKDC highest lumen efficacy LED

Power consumption	Supply voltage	Supply current
40W/m (12.19W/ft)	24V DC	1.67A/m (0.51A/ft)

Performance Data (3000K)

A-line	R1	R2	R3	R4	R5	R6	R7	R8	R9	R10	R11	R12	R13	R14
A-line	95	95	94	95	94	94	95	90	75	88	95	78	95	96

	Clear Cover	Diffused Cover	CRI	R9	Rf	Rg
A-line	3080lm/m (939lm/ft) 77lm/W	2120lm/m (646lm/ft) 53lm/W	94	75	-	-

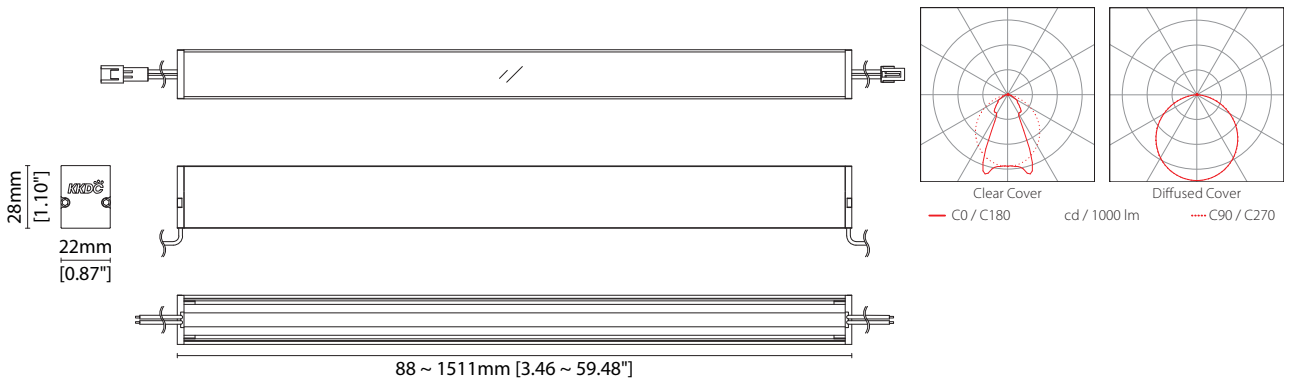

Data derived from independent UKAS/IESNA LM-79-08 accredited testing of production samples.

LINI-S XL A040 (40W)

Code Table



FIXTURE

Model	Finish	Cover/Lens ¹	Grade ²	LED	Colour (CCT)	Length Availability ³	IP	Cable Length	Power Feed ⁴	Input											
LINI-S XL	SX	Silver Anodised	SA	Clear	B	A-	A	A040	A040	2700K	27	m	88-1511mm 38.46mm increments	IP40	40	300mm/11.81"	0300	Single no sheath tail	S00X	DC 24V	g
										3000K	30					1000mm/39.37"					
		3500K	35	i	3.46-59.49in 1.51in increments	Double no sheath tail	D00X														
		4000K	40					(Specify length code OR total run length)	Single no sheath IP20 connector	S20X											
Double no sheath IP20 connector	D20X																				

¹ Refer to **Cover/Lens Options** on **Options** pages ² Refer to **LED Grading Key** on **Specification sheet** page ³ Refer to **Length Availability List** or enter total run length instead of length code

⁴ Refer to **Power Feed Options** on **Options** pages

Code Example:

SX	-	SA	-	C	-	A	-	040	-	30	-	m	-	511	-	40	-	0300	-	D00X	-	g
LINI-S XL		Silver Anodised		Diffused		A-		A040		3000K		511mm		IP40		300mm/11.81"		0300		Double no sheath tail		DC 24V

ACCESSORIES

Mounting Accessories

KKCP-11	Concealed Clip
KKCR-01-1000	1000mm/39.37" Cable Raceway
KKCR-01-2000	2000mm/78.74" Cable Raceway
KKCR-01-3000	3000mm/118.11" Cable Raceway
KKJT-02	Joining Bar

Connection Accessories

KKCN-01	2 PIN male & female 50mm/1.97" pair
KKCN-03	2 PIN male & female 300mm/11.81" pair
KKCN-06	2 PIN 300mm/11.81" extension lead

* Refer to **Power feed** on **Accessories** pages

PSU/Driver

0-10V/1-10V/DALI/DMX

* Refer to **Driver/PSU Options** page for details or provide requirement and KKDC to offer the suitable option

* Refer to **Mounting accessories** on **Accessories** pages

LED ENGINE VARIANTS (LED STRIP TYPE)

Colour	LED	Lumen/m	Lumen/ft	W/m	W/ft	Spec Doc	Length	Increment
Single CCT	R007	423	129	7	2.13	LINI-S XL R007	94-2011mm/3.71-79.17in	41.7mm/1.64in
	R014	772	235	14	4.27	LINI-S XL R014	94-2011mm/3.71-79.17in	41.7mm/1.64in
	R020	1230	375	20	6.10	LINI-S XL R020	94-2011mm/3.71-79.17in	41.7mm/1.64in
	A040	3080	939	40	12.19	LINI-S XL A040	88.0-1511mm/3.46-59.49in	38.46mm/1.51in
Warm Dim/Dynamic White	R207	423	129	16	4.88	LINI-S XL R207	94-2011mm/3.71-79.17in	41.7mm/1.64in
RGB	501	Red 85 Green 184 Blue 30 RGB 267	Red 26 Green 56 Blue 9 RGB 81	15.6	4.75	LINI-S XL RGB	94-2011mm/3.71-79.17in	41.7mm/1.64in
RGBW	R201	727	222	20	6.10	LINI-S XL RGBW	136-2011mm/5.35-79.17in	62.5mm/2.46in

* Performance data: A/S-line, clear cover, 3000K

Linear

LINI-S XL A040 (40W)

Length Availability List



Length Code		Fixture Length ¹		LED Strip ²		End Cap Dimension ³		Wattage (W)	Output (lm)
Metric	Imperial(US)	Metric	Imperial(US)	Metric	Imperial(US)	Metric	Imperial(US)		3000K (Test Data)
m0088	i0003	88mm	3.46in	77mm	3.03in	6mm	0.24in	3.08	237
m0126	i0005	126mm	4.98in	115mm	4.55in	6mm	0.24in	4.62	356
m0165	i0006	165mm	6.49in	154mm	6.06in	6mm	0.24in	6.16	474
m0203	i0008	203mm	8.01in	192mm	7.57in	6mm	0.24in	7.70	593
m0242	i0010	242mm	9.52in	231mm	9.09in	6mm	0.24in	9.23	711
m0280	i0011	280mm	11.04in	269mm	10.60in	6mm	0.24in	10.77	829
m0319	i0013	319mm	12.55in	308mm	12.12in	6mm	0.24in	12.31	948
m0357	i0014	357mm	14.06in	346mm	13.63in	6mm	0.24in	13.85	1066
m0396	i0016	396mm	15.58in	385mm	15.14in	6mm	0.24in	15.39	1185
m0434	i0017	434mm	17.09in	423mm	16.66in	6mm	0.24in	16.93	1303
m0473	i0019	473mm	18.61in	462mm	18.17in	6mm	0.24in	18.46	1422
m0511	i0020	511mm	20.12in	500mm	19.69in	6mm	0.24in	20.00	1540
m0550	i0022	550mm	21.63in	539mm	21.20in	6mm	0.24in	21.54	1659
m0588	i0023	588mm	23.15in	577mm	22.72in	6mm	0.24in	23.08	1777
m0626	i0025	626mm	24.66in	615mm	24.23in	6mm	0.24in	24.62	1896
m0665	i0026	665mm	26.18in	654mm	25.74in	6mm	0.24in	26.16	2014
m0703	i0028	703mm	27.69in	692mm	27.26in	6mm	0.24in	27.69	2132
m0742	i0029	742mm	29.21in	731mm	28.77in	6mm	0.24in	29.23	2251
m0780	i0031	780mm	30.72in	769mm	30.29in	6mm	0.24in	30.77	2369
m0819	i0032	819mm	32.23in	808mm	31.80in	6mm	0.24in	32.31	2488
m0857	i0034	857mm	33.75in	846mm	33.31in	6mm	0.24in	33.85	2606
m0896	i0035	896mm	35.26in	885mm	34.83in	6mm	0.24in	35.39	2725
m0934	i0037	934mm	36.78in	923mm	36.34in	6mm	0.24in	36.92	2843
m0973	i0038	973mm	38.29in	962mm	37.86in	6mm	0.24in	38.46	2962
m1011	i0040	1011mm	39.80in	1000mm	39.37in	6mm	0.24in	40.00	3080
m1050	i0041	1050mm	41.32in	1039mm	40.89in	6mm	0.24in	41.54	3199
m1088	i0043	1088mm	42.83in	1077mm	42.40in	6mm	0.24in	43.08	3317
m1126	i0044	1126mm	44.35in	1115mm	43.91in	6mm	0.24in	44.62	3435
m1165	i0046	1165mm	45.86in	1154mm	45.43in	6mm	0.24in	46.16	3554
m1203	i0047	1203mm	47.38in	1192mm	46.94in	6mm	0.24in	47.69	3672
m1242	i0049	1242mm	48.89in	1231mm	48.46in	6mm	0.24in	49.23	3791
m1280	i0050	1280mm	50.40in	1269mm	49.97in	6mm	0.24in	50.77	3909
m1319	i0052	1319mm	51.92in	1308mm	51.49in	6mm	0.24in	52.31	4028
m1357	i0053	1357mm	53.43in	1346mm	53.00in	6mm	0.24in	53.85	4146
m1396	i0055	1396mm	54.95in	1385mm	54.51in	6mm	0.24in	55.39	4265
m1434	i0056	1434mm	56.46in	1423mm	56.03in	6mm	0.24in	56.92	4383
m1473	i0058	1473mm	57.97in	1462mm	57.54in	6mm	0.24in	58.46	4502
m1511	i0059	1511mm	59.49in	1500mm	59.06in	6mm	0.24in	60.00	4620

¹ Actual total overall length of light fixture (LED strip + end caps + void/wire hole)

² Actual length of PCB strip

³ Actual length of 2x end caps

Linear

LINI-S XL A040 (40W)

Length Availability List

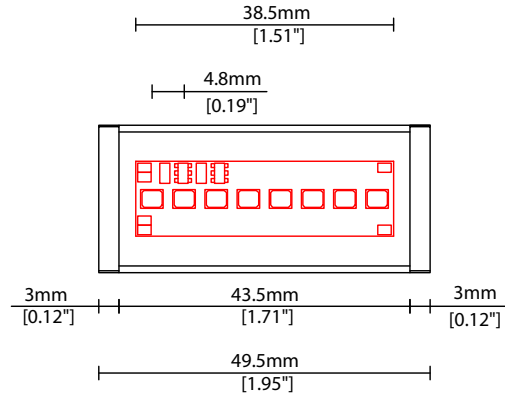

Linear

LINI-S XL A040 (40W)

Options

KKDC

COVER/LENS OPTIONS

* Options are an integral part of the fixture ordering codes. Please refer to **Code Table** pages.

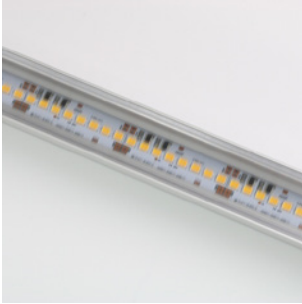

B Clear cover

W22/H27.9mm (W0.87/H1.10")

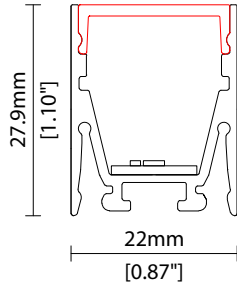

C Diffused cover

W22/H27.9mm (W0.87/H1.10")

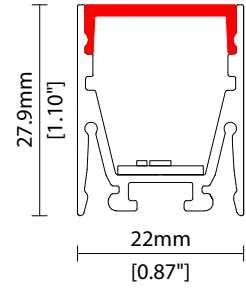

POWER FEED OPTIONS

0300 S00X 300mm (11.81") Single no sheath tail

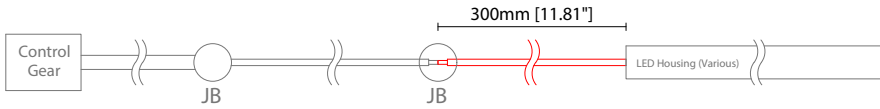

0300 D00X 300mm (11.81") Double no sheath tail

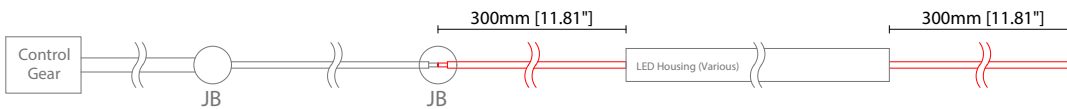

0300 S20X 300mm (11.81") Single no sheath IP20 connector

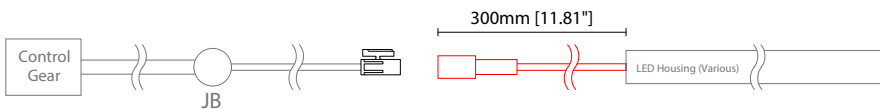

0300 D20X 300mm (11.81") Double no sheath IP20 connector

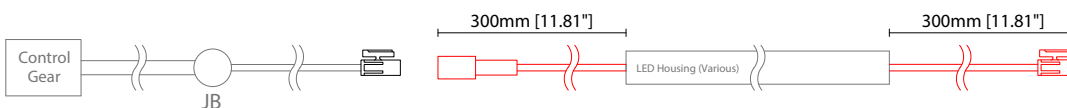

1000 S00X 1000mm (39.37") Single no sheath tail

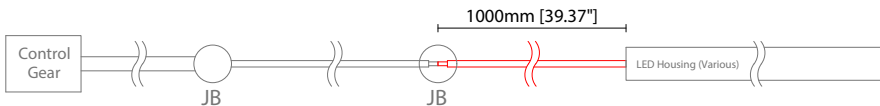

1000 D00X 1000mm (39.37") Double no sheath tail

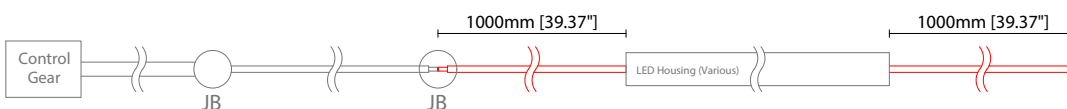

1000 S20X 1000mm (39.37") Single no sheath IP20 connector

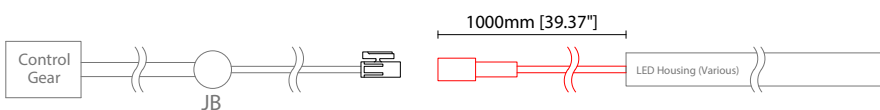

1000 D20X 1000mm (39.37") Double no sheath IP20 connector

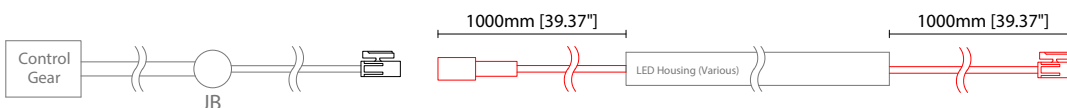

Key

Control Gear Power supply, sub-controllers & control systems

JB Junction box / cable connection

Linear

LINI-S XL A040 (40W)

Options



POWER FEED OPTIONS (CONTINUED)

2 Pin Female Connector

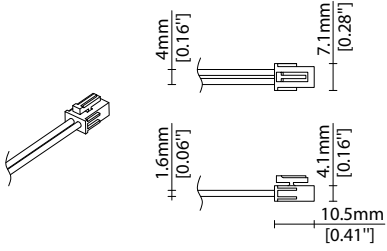

2 Pin Male Connector

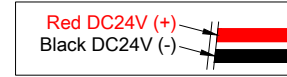
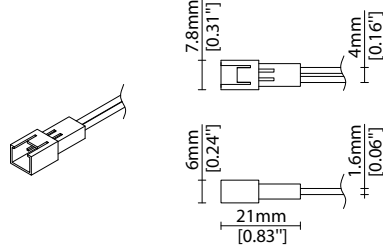

Linear

LINI-S XL A040 (40W) Accessories

KKDÖ

MOUNTING ACCESSORIES

Note: Accessories are to be ordered separately with corresponding code shown below.



KKCP-11

Concealed clip
(allow 3 per metre/40in)
S/Steel finish
L20/W22/H28.1mm
(L0.79/W0.87/H1.11")

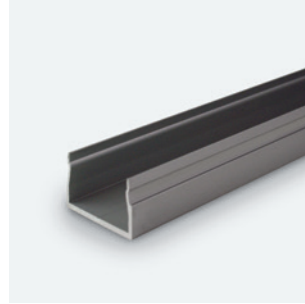
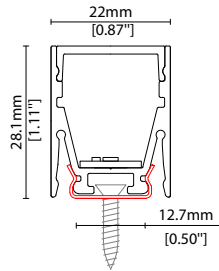

- KKCR-01-1000 1000mm (39.37in)
- KKCR-01-2000 2000mm (78.74in)
- KKCR-01-3000 3000mm (118.11in)

Cable raceway*
anodised aluminium finish
W22/H36.4mm (W0.87/H1.43")

* Cut & drilled to fit on site

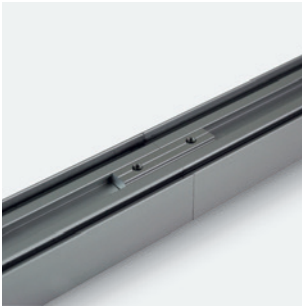
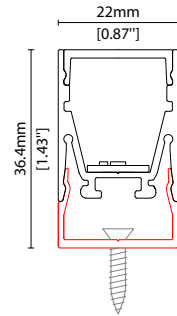

KKJT-02

Joining bar* (allow 1 per join)
anodised aluminium finish
L25mm (L0.98")

* Mounting option required with
Joining bar

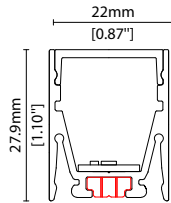

Linear

LINI-S XL A040 (40W)

Accessories

KKDC

POWER FEED

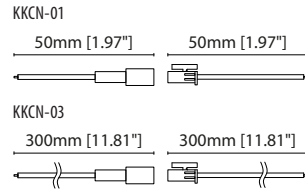
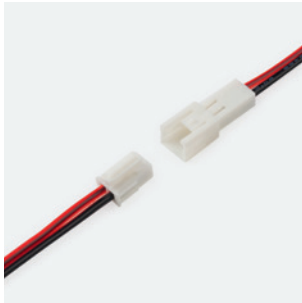

KKCN-01 50mm (1.97in) pair
KKCN-03 300mm (11.81in) pair
2 PIN male + female connector set

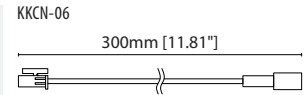

KKCN-06
2 PIN 300mm (11.81in) extension lead

KKDC CONTROL



IP20
Plastic housing
L170/W59/H29mm
(L6.69/W2.32/H1.14in)

KKDM-06 1-10V
visDIM dimmable sub-controller
(4 x 8A max @ 12-36V)



IP20
Plastic housing
L170/W53.4/H28mm
(L6.69/W2.10/H1.10in)

KKSC-05 DMX
visDIM dimmable sub-controller
(4 x 5A max @ 12-36V)



IP20
Plastic housing
L170/W59/H29mm
(L6.69/W2.32/H1.14in)

KKDL-02 DALI
visDIM dimmable sub-controller
(4 x 8A max @ 12-36V)



IP20
Plastic housing
L166/W53.4/H23mm
(L6.54/W2.10/H0.91in)

KKDL-03 DALI
visDIM dimmable sub-controller
(4 x 5A max @ 12-36V)

AVAILABLE PSU OPTIONS

Control Mode	PSU (Order Code)	Input Voltage AC	Output Voltage DC	Rated Output Current	Rated Power	Dim %	IP Rating
Switched	CEN-60-24	90-295V	24V	2.5A	60W	-	IP67
	HLG-60H-24	90-305V	24V	2.5A	60W	-	IP67
	HLG-100H-24	90-305V	24V	4.0A	100W	-	IP67
	HLG-150H-24	90-305V	24V	6.3A	150W	-	IP67
	HLG-240H-24	90-305V	24V	10A	240W	-	IP67
0-10V (1-10V)	PWM-40-24	90-305V	24V	1.67A	40W	100-0.15 (100-10)	IP67
	PWM-60-24	90-305V	24V	2.5A	60W	100-0.15 (100-10)	IP67
	PWM-90-24	90-305V	24V	3.67A	90W	100-0.15 (100-10)	IP67
	PWM-120-24	90-305V	24V	5.0A	120W	100-0.15 (100-10)	IP67
DALI	LIN100A1	120-277V	24V	1A per channel	100W	100-0.1	IP66/IP40
DMX RGB	LIN100A1	120-277V	24V	1.33A per channel	100W	100-0.1	IP66/IP40
DMX RGBW	LIN100A1	120-277A	24V	1A per channel	100W	100-0.1	IP66/IP40

Flicker Free Options - Combination of PSU+ sub-controller

Control Mode	PSU (Order Code)	Sub-controller (Order Code)	Input Voltage AC	Output Voltage DC	Rated Output Current	Rated Power	Dim %	IP Rating PSU/ Sub-controller
0-10V or 1-10V	CEN-60-24	KKDM-06	90-295V	24V	2.5A	60W	100-0.9	IP67/IP20
	HLG-60H-24	KKDM-06	90-295V	24V	2.5A	60W	100-0.9	IP67/IP20
	HLG-100H-24	KKDM-06	90-295V	24V	4.0A	100W	100-0.9	IP67/IP20
	HLG-150H-24	KKDM-06	90-295V	24V	6.3A	150W	100-0.9	IP67/IP20
	HLG-240H-24	KKDM-06	90-295V	24V	10.0A	240W	100-0.9	IP67/IP20
DALI	CEN-60-24	KKDL-02/03	90-295V	24V	2.5A	60W	100-0.1	IP67/IP20
	HLG-60H-24	KKDL-02/03	90-305V	24V	2.5A	60W	100-0.1	IP67/IP20
	HLG-100H-24	KKDL-02/03	90-305V	24V	4.0A	100W	100-0.1	IP67/IP20
	HLG-150H-24	KKDL-02/03	90-305V	24V	6.3A	150W	100-0.1	IP67/IP20
	HLG-240H-24	KKDL-02/03	90-305V	24V	10.0A	240W	100-0.1	IP67/IP20
DMX RGB	CEN-60-24	KKSC-05	90-295V	24V	2.5A	60W	100-0.9	IP67/IP20
	HLG-60H-24	KKSC-05	90-305V	24V	2.5A	60W	100-0.9	IP67/IP20
	HLG-100H-24	KKSC-05	90-305V	24V	4A	100W	100-0.9	IP67/IP20
	HLG-150H-24	KKSC-05	90-305V	24V	6.3A	150W	100-0.9	IP67/IP20
	HLG-240H-24	KKSC-05	90-305V	24V	10.0A	240W	100-0.9	IP67/IP20

¹ The items shown above cover the most frequently used specification but does not exhaust the possible options

² PSU and/or driver can be chosen from the table, or KKDC may recommend the best option upon receipt of the controls requirement and installation environment

³ Electrical shop drawing will include detailed information of PSU and relevant control drivers

⁴ Cut sheets are available on the controls section of www.kkdc.lighting or upon request